

## Piano Urbanistico Comunale

Piano di utilizzo del Litorale

# Comune di Muravera

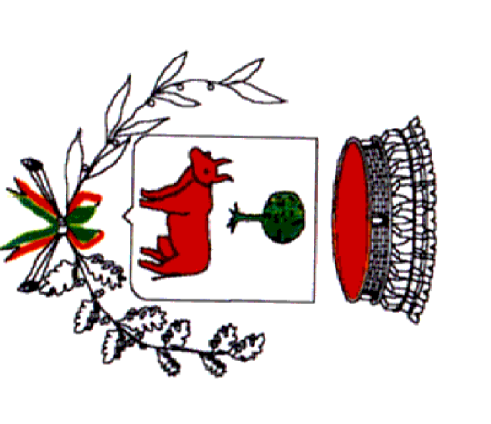

ALTANA - Pianta  
SCALA 1:100

### Tav. 6a

PIANTA QUOTATA (1:100)

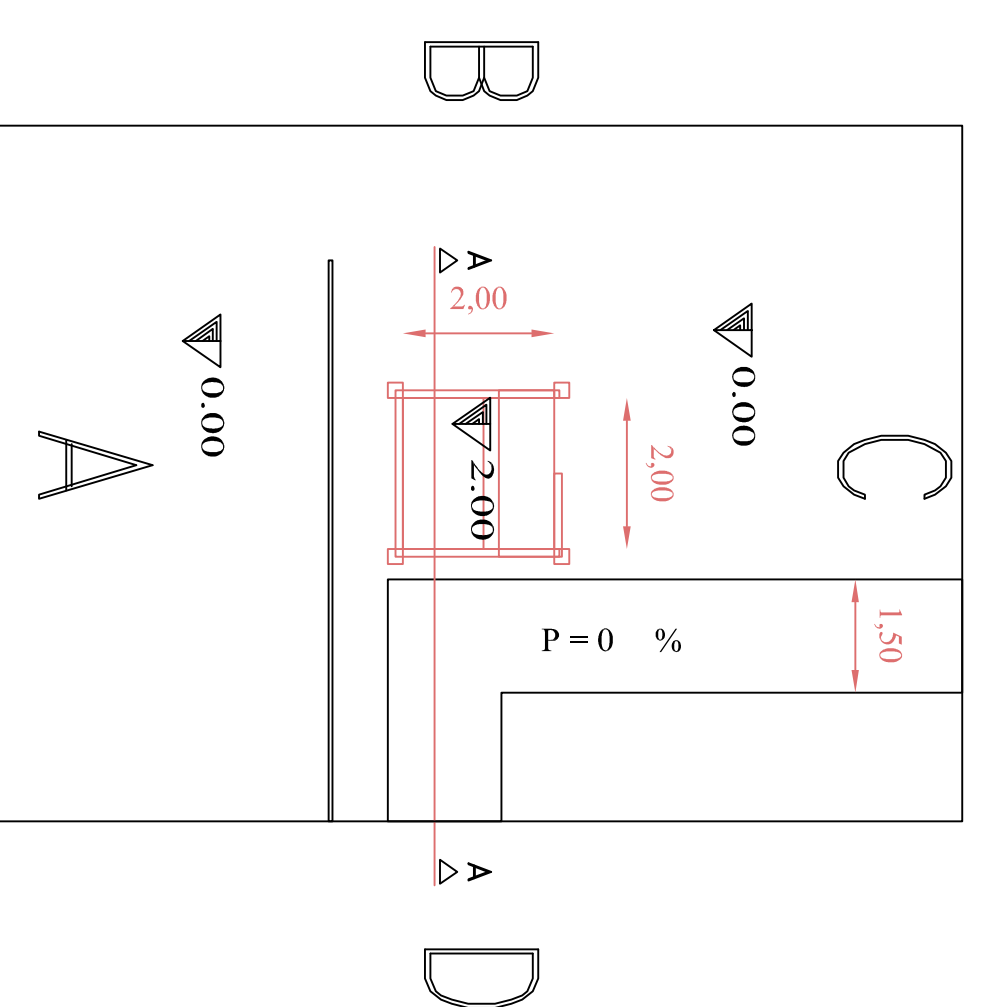

PIANTA DESCR. MATERIALI (1:100)

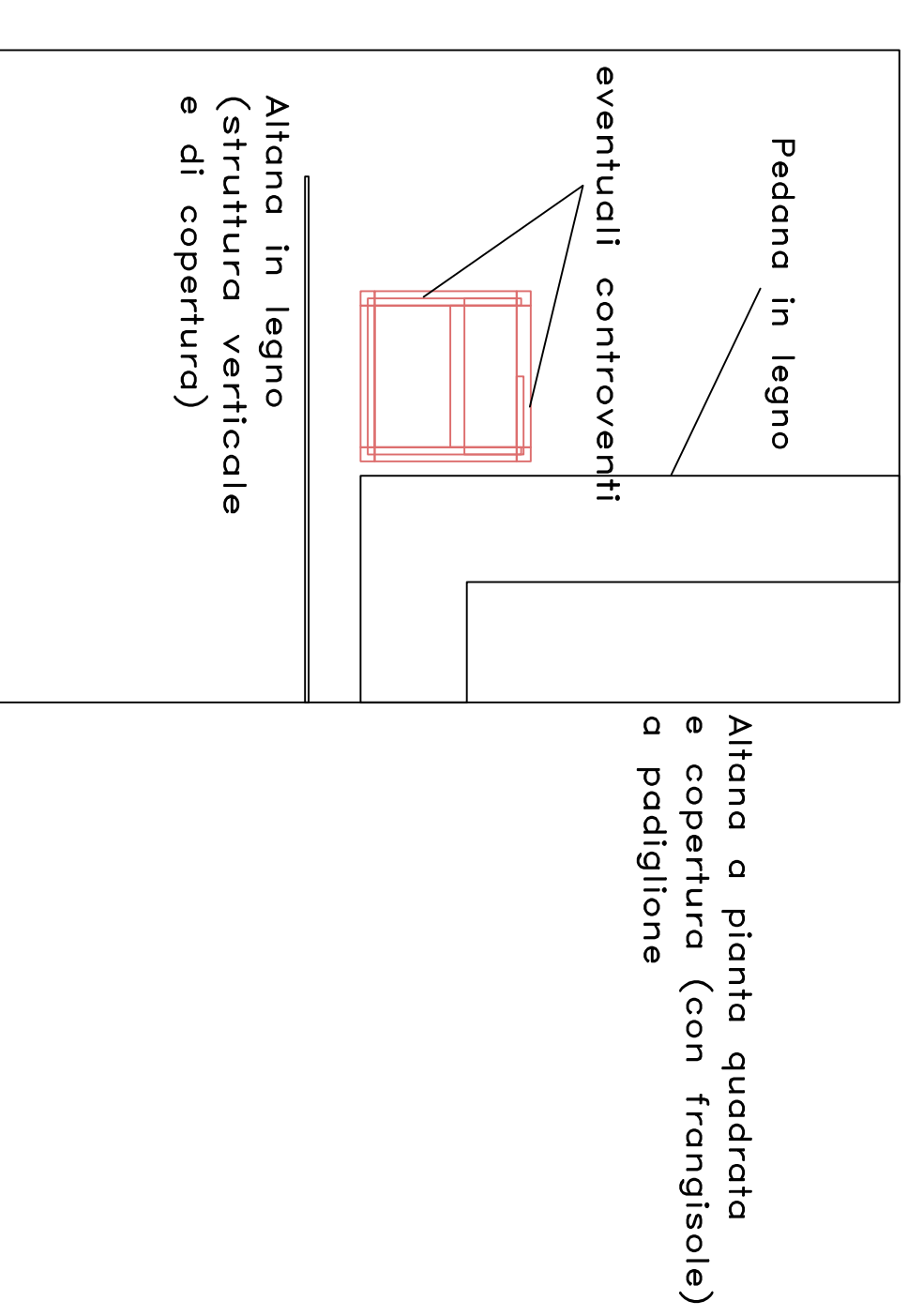

PIANTA COPERTURA (1:100)

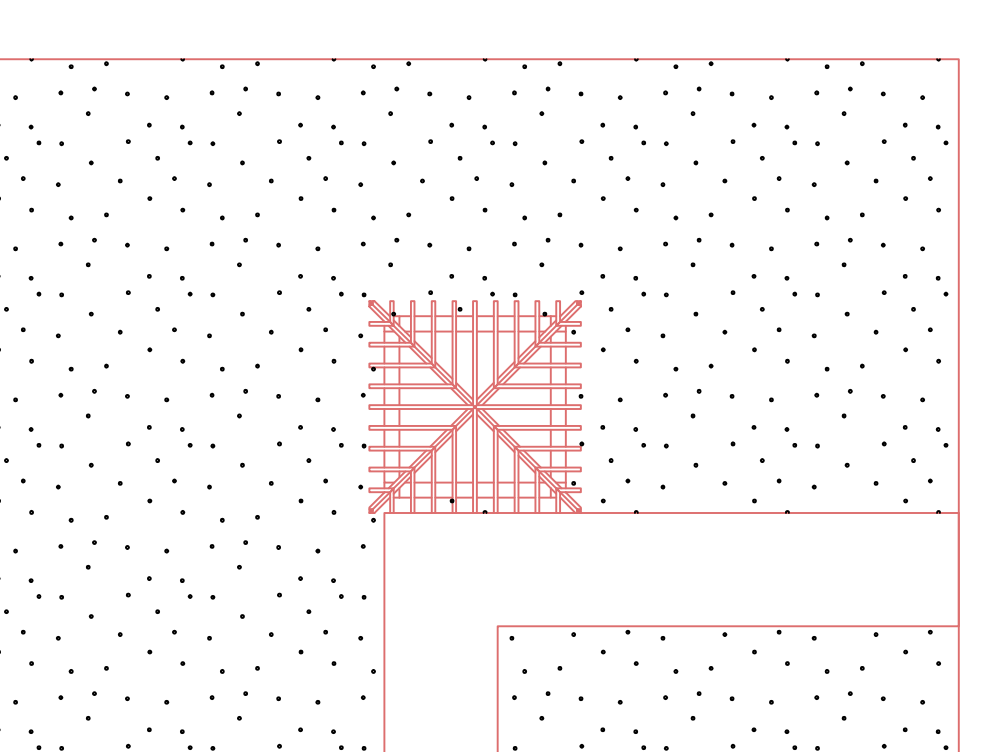

Dr. Ing. Paolo Altiero - Coordinatore del progetto  
Geom. Roberto Deiana - Progettista

## Piano Urbanistico Comunale

Piano di utilizzo del Litorale

# Comune di Muravera

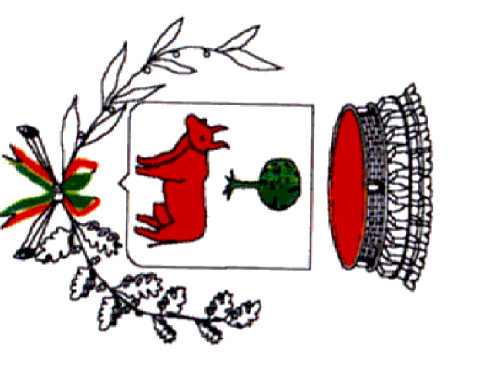

ALTANA - Prospetti e Sezione  
SCALA 1:100

### Tav. 6b

PROSPETTO A (1:100)

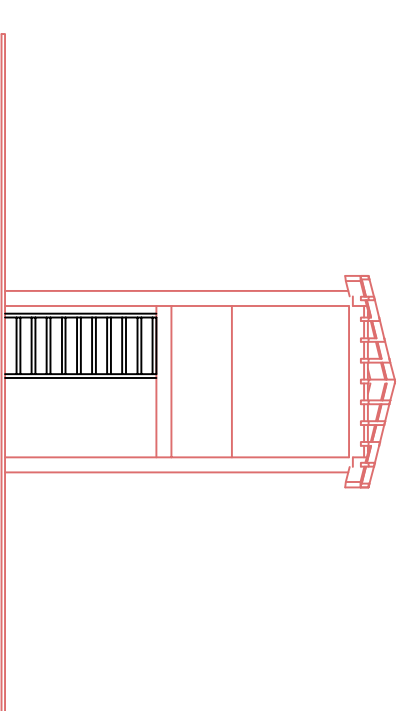

PROSPETTO B (1:100)

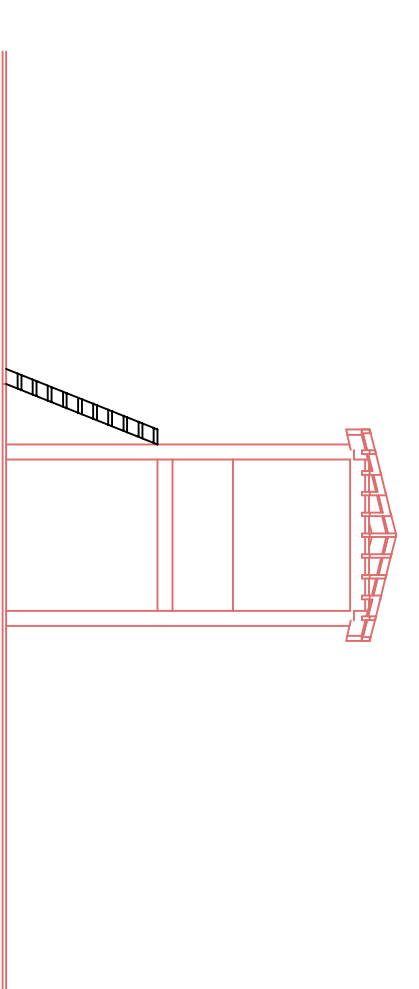

SEZIONE A-A (1:100)

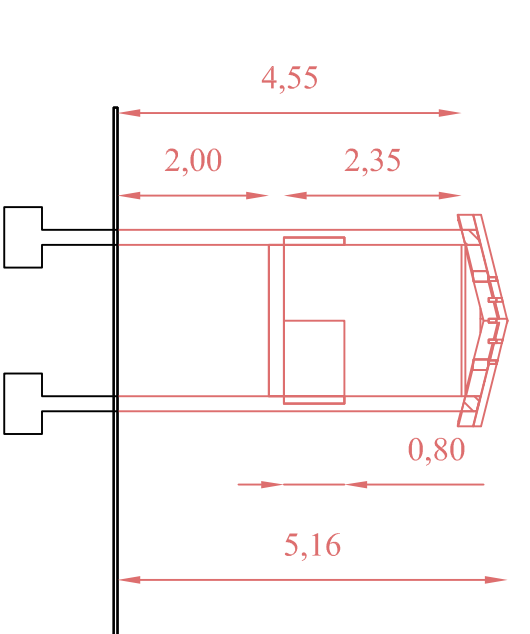

PROSPETTO C (1:100)

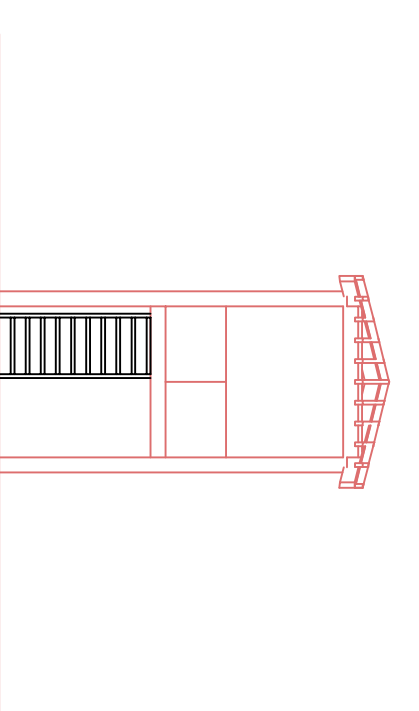

PROSPETTO D (1:100)

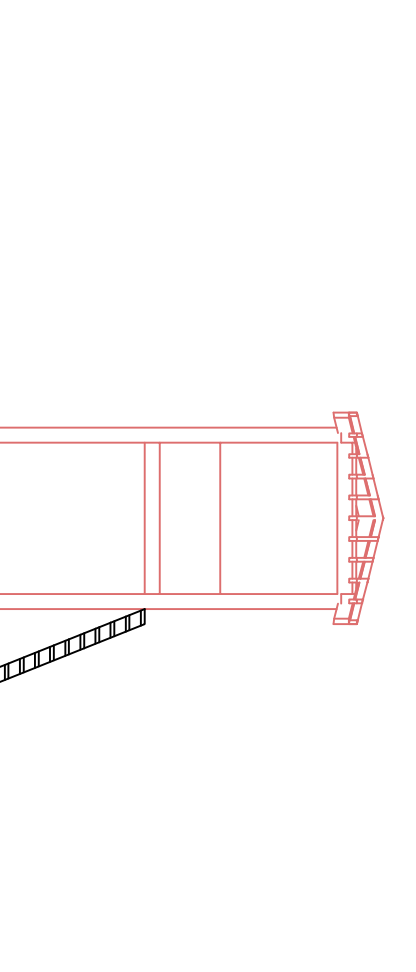

Dr. Ing. Paolo Altiero - Coordinatore del progetto  
Geom. Roberto Deiana - Progettista



ERROR: syntaxerror  
OFFENDING COMMAND: --nostringval--

STACK:

/Title  
( )  
/Subject  
(D:20100104125733+01'00')  
/ModDate  
( )  
/Keywords  
(PDFCreator Version 0.9.5)  
/Creator  
(D:20100104125733+01'00')  
/CreationDate  
(Soft)  
/Author  
-mark-